

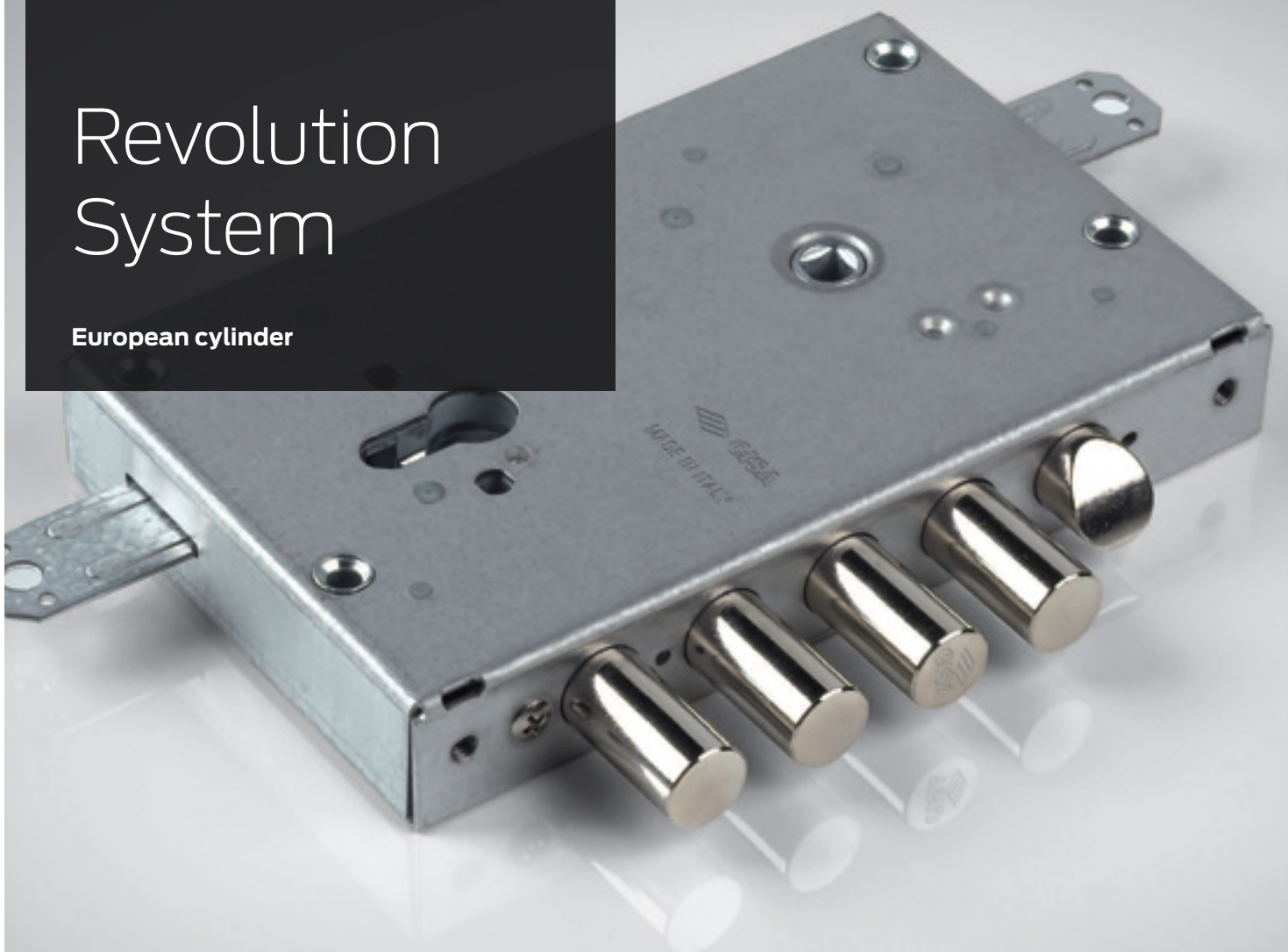

Revolution System

European cylinder



European cylinder Revolution System

OPERATION

- Smaller, lighter key than in traditional bitted key systems.
- Revolution is fitted with a special, effort-reducing gear mechanism which ensures smooth key rotation when operating the lock.
- Revolution has been specially designed to enable the fitting of additional locking points without impairing the smoothness of operation.

SECURITY

Security is guaranteed by the CISA European profile cylinders, true technological jewels.

- The Revolution System, installed with the CISA cylinders AP3 and/or RS3, and series 06480 and/or 06485 protective roses, meets the top security requirements provided for by the European standards EN 1303 and UNI EN 12209:03.

AVAILABLE MODELS

- With and without latch-bolt, with electrically operated latch-bolt, with front locking or three locking points.

- Double lock version (Multifunction Cylinder/Cylinder): 2 locks, coupled to obtain a single product carrying out different types of function for enhanced handiness and security.

RANGE

Developed according to 2 dimensional standards to meet any installation requirements.

CERTIFICATES

All Revolution locks have been designed and tested to meet the strictest requirements provided for by the Draft European Standard UNI EN 12209:03.

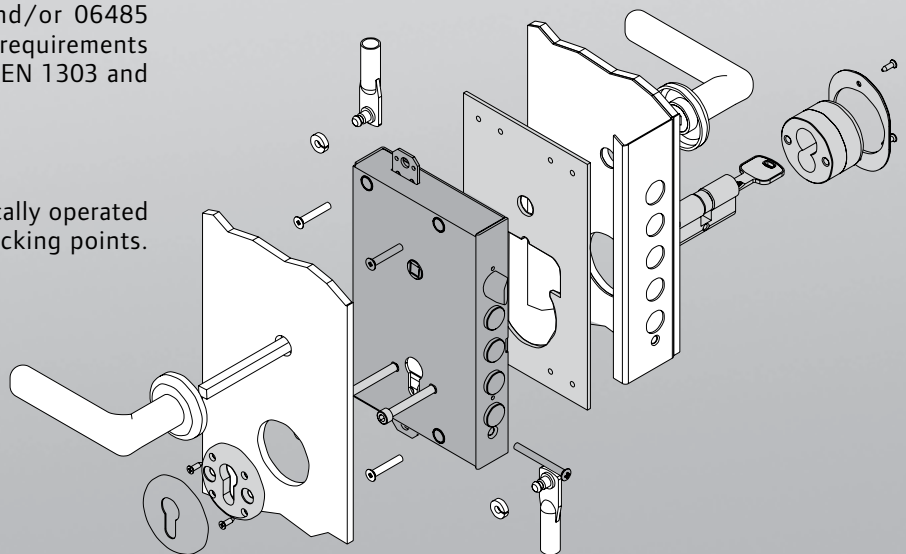

**Technical features:**

- Steel case and cover.
- Nickel-plated steel faceplate (mortice locks).
- Nickel-plated steel deadbolts.
- Non-handed nickel-plated latch-bolt.
- Anti-picking latch-bolt (electrically operated locks).
- Nickel-plated reloading pin (electrically operated locks).
- Coil set with built-in terminal block, 12 V, 15 W ac (electrically operated locks).
- Anti-crush plates for screw fixing.
- Steel active pins.
- Effort reducing gears operated by the key turnin in the cylinder.
- Packaging: 1 or 5 pieces (industrial packs).

Operation:

- From the inside: the latch-bolt can be remotely controlled (electrically controlled locks) or key- or handle-operated; the dead-bolts are key-operated.
- From the outside: the latch-bolt and dead-bolts are operated with the key.

Finishes:

- Zinc plated aluminium.

R./L. Hand Opening:

0 = non-handed.

On request:

- European profile cylinder.
- Cylinder protective roses series 06460; 06480; 06485.
- Electric contacts item 1.06510.0.
- Striking plate item 1.06220.20.0.
- Inside escutcheons item 06473.

Type	Description	Dead-bolts								ITEM						
		No.	Projection	Distance	Throws	Distance	Faceplate	Backset	Unit weight Kg	Pieces	Type	Dim.	Hand	Fin.	Pers.	Spec.
	<ul style="list-style-type: none"> • Latch-bolt and dead-bolt • Electrically controlled dead-locking latch-bolt • Voltage: 12 V ac CE • Slide item 1.06224.50.0 	4	3,5	25	2	85	-	64	2,330	1	1 15510 25 0					
		4	3,5	27	2	85	-	64	2,330	1	1 15510 27 0					
		4	3,5	28	2	85	-	64	2,330	1	1 15510 28 0					
		3	3,5	32	2	85	-	64	2,330	1	1 15510 32 0					
		3	3,5	38	2	85	-	64	2,330	1	1 15510 38 0					
		4	3,5	25	2	85	-	64	2,030	5	1 15510 45 0					
		4	3,5	27	2	85	-	64	2,030	5	1 15510 47 0					
		4	3,5	28	2	85	-	64	2,030	5	1 15510 48 0					
		3	3,5	32	2	85	-	64	2,030	5	1 15510 52 0					
		3	3,5	38	2	85	-	64	2,030	5	1 15510 58 0					
	<ul style="list-style-type: none"> • Latch-bolt and dead-bolt • Electrically controlled dead-locking latch-bolt • Voltage: 12 V ac CE • Slide item 1.06224.50.0 • Pre-setting for additional locking points 	4	3,5	25	2	85	-	64	2,520	1	1 15515 25 0					
		4	3,5	27	2	85	-	64	2,520	1	1 15515 27 0					
		4	3,5	28	2	85	-	64	2,660	1	1 15515 28 0					
		3	3,5	32	2	85	-	64	2,520	1	1 15515 32 0					
		3	3,5	38	2	85	-	64	2,520	1	1 15515 38 0					
		4	3,5	25	2	85	-	64	2,220	5	1 15515 45 0					
		4	3,5	27	2	85	-	64	2,220	5	1 15515 47 0					
		4	3,5	28	2	85	-	64	2,430	5	1 15515 48 0					
		3	3,5	32	2	85	-	64	2,220	5	1 15515 52 0					
		3	3,5	38	2	85	-	64	2,220	5	1 15515 58 0					
	<ul style="list-style-type: none"> • Dead-bolt only 	5	3,5	25	2	85	-	64	2,190	1	1 56500 25 0					
		5	3,5	27	2	85	-	64	2,190	1	1 56500 27 0					
		5	3,5	28	2	85	-	64	2,190	1	1 56500 28 0					
		4	3,5	32	2	85	-	64	2,190	1	1 56500 32 0					
		4	3,5	38	2	85	-	64	2,190	1	1 56500 38 0					
		5	3,5	25	2	85	-	64	1,890	5	1 56500 45 0					
		5	3,5	27	2	85	-	64	1,890	5	1 56500 47 0					
		5	3,5	28	2	85	-	64	1,890	5	1 56500 48 0					
		4	3,5	32	2	85	-	64	1,890	5	1 56500 52 0					
		4	3,5	38	2	85	-	64	1,890	5	1 56500 58 0					
	<ul style="list-style-type: none"> • Dead-bolt only • Pre-setting for additional locking points 	5	3,5	25	2	85	-	64	2,370	1	1 56505 25 0					
		5	3,5	27	2	85	-	64	2,370	1	1 56505 27 0					
		5	3,5	28	2	85	-	64	2,370	1	1 56505 28 0					
		4	3,5	32	2	85	-	64	2,370	1	1 56505 32 0					
		4	3,5	38	2	85	-	64	2,370	1	1 56505 38 0					
		5	3,5	25	2	85	-	64	2,070	5	1 56505 45 0					
		5	3,5	27	2	85	-	64	2,070	5	1 56505 47 0					
		5	3,5	28	2	85	-	64	2,070	5	1 56505 48 0					
		4	3,5	32	2	85	-	64	2,070	5	1 56505 52 0					
		4	3,5	38	2	85	-	64	2,070	5	1 56505 58 0					
	<ul style="list-style-type: none"> • Latch-bolt and dead-bolt 	4	3,5	25	2	85	-	64	2,140	1	1 56510 25 0					
		4	3,5	27	2	85	-	64	2,140	1	1 56510 27 0					
		4	3,5	28	2	85	-	64	2,440	1	1 56510 28 0					
		3	3,5	32	2	85	-	64	2,140	1	1 56510 32 0					
		3	3,5	38	2	85	-	64	2,140	1	1 56510 38 0					
		4	3,5	25	2	85	-	64	1,840	5	1 56510 45 0					
		4	3,5	27	2	85	-	64	1,840	5	1 56510 47 0					
		4	3,5	28	2	85	-	64	1,840	5	1 56510 48 0					
		3	3,5	32	2	85	-	64	1,840	5	1 56510 52 0					
		3	3,5	38	2	85	-	64	1,840	5	1 56510 58 0					

Type	Description	Dead-bolts								ITEM					
		No.	Projection	Distance	Throws	Distance	Faceplate	Backset	Unit weight Kg	Pieces	Type	Dim.	Hand	Fin.	Pers. Spec.
	<ul style="list-style-type: none"> • Latch-bolt and dead-bolt • Pre-setting for additional locking points 	4	3,5	25	2	85	-	64	2,320	1	1 56515 25 0				
		4	3,5	27	2	85	-	64	2,320	1	1 56515 27 0				
		4	3,5	28	2	85	-	64	2,320	1	1 56515 28 0				
		3	3,5	32	2	85	-	64	2,320	1	1 56515 32 0				
		3	3,5	38	2	85	-	64	2,320	1	1 56515 38 0				
		4	3,5	25	2	85	-	64	2,020	5	1 56515 45 0				
		4	3,5	27	2	85	-	64	2,020	5	1 56515 47 0				
		4	3,5	28	2	85	-	64	2,360	5	1 56515 48 0				
		3	3,5	32	2	85	-	64	2,020	5	1 56515 52 0				
3	3,5	38	2	85	-	64	2,020	5	1 56515 58 0						
	<ul style="list-style-type: none"> • Latch-bolt and dead-bolt • Pre-setting for additional locking points 	4	3,5	27	2	92	-	64	2,320	1	1 56615 27 0				
		4	3,5	28	2	92	-	64	2,320	1	1 56615 28 0				
		3	3,5	38	2	92	-	64	2,320	1	1 56615 38 0				
		4	3,5	27	2	92	-	64	2,020	5	1 56615 47 0				
		4	3,5	28	2	92	-	64	2,360	5	1 56615 48 0				
3	3,5	38	2	92	-	64	2,020	5	1 56615 58 0						
	<ul style="list-style-type: none"> • Dead-bolt only • Pre-setting for additional locking points 	5	3,5	25	2	85	-	64	2,370	1	1 B6505 25 0				
		5	3,5	28	2	85	-	64	2,370	1	1 B6505 28 0				
		4	3,5	38	2	85	-	64	2,370	1	1 B6505 38 0				
		5	3,5	25	2	85	-	64	2,070	5	1 B6505 45 0				
		5	3,5	28	2	85	-	64	2,070	5	1 B6505 48 0				
4	3,5	38	2	85	-	64	2,070	5	1 B6505 58 0						
	<ul style="list-style-type: none"> • Latch-bolt and dead-bolt • Pre-setting for additional locking points 	4	3,5	25	2	85	-	64	2,320	1	1 B6515 25 0				
		4	3,5	28	2	85	-	64	2,320	1	1 B6515 28 0				
		3	3,5	38	2	85	-	64	2,320	1	1 B6515 38 0				
		4	3,5	25	2	85	-	64	2,020	5	1 B6515 45 0				
		4	3,5	28	2	85	-	64	2,360	5	1 B6515 48 0				
3	3,5	38	2	85	-	64	2,020	5	1 B6515 58 0						
	<ul style="list-style-type: none"> • Latch-bolt and dead-bolt • Pre-setting for additional locking points 	4	3,5	28	2	92	-	64	2,320	1	1 B6615 28 0				
		3	3,5	38	2	92	-	64	2,320	1	1 B6615 38 0				
		4	3,5	28	2	92	-	64	2,360	5	1 B6615 48 0				
		3	3,5	38	2	92	-	64	2,020	5	1 B6615 58 0				

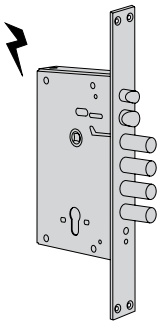
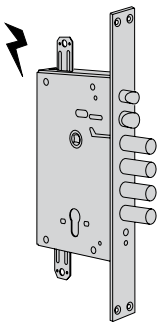
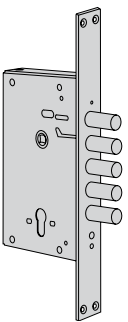
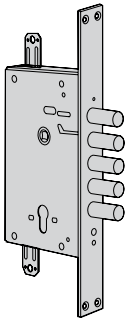
Type	Description	Dead-bolts								ITEM						
		No.	Projection	Distance	Throws	Distance	Faceplate	Backset	Unit weight Kg	Pieces	Type	Dim.	Hand	Fin.	Pers.	Spec.
	<ul style="list-style-type: none"> • Latch-bolt and dead-bolt • Electrically controlled dead-locking latch-bolt • Voltage: 12 V ac CE • Slide item 1.06224.50.0 	4	-	28	2	85	35	67	2,600	1	1	15530	28	0		
		4	-	28	2	85	35	67	2,300	5	1	15530	48	0		
	<ul style="list-style-type: none"> • Latch-bolt and dead-bolt • Electrically controlled dead-locking latch-bolt • Voltage: 12 V ac CE • Slide item 1.06224.50. • Pre-setting for additional locking points 	4	-	28	2	85	35	67	2,790	1	1	15535	28	0		
		4	-	28	2	85	35	67	2,490	5	1	15535	48	0		
	<ul style="list-style-type: none"> • Dead-bolt only 	5	-	28	2	85	35	67	2,550	1	1	56520	28	0		
		5	-	28	2	85	35	67	2,250	5	1	56520	48	0		
	<ul style="list-style-type: none"> • Dead-bolt only • Pre-setting for additional locking points 	5	-	28	2	85	35	67	2,650	1	1	56525	28	0		
		5	-	28	2	85	35	67	2,350	5	1	56525	48	0		

Type	Description	Dead-bolts								ITEM					
		No.	Projection	Distance	Throws	Distance	Faceplate	Backset	Unit weight Kg	Pieces	Type	Dim.	Hand	Fin.	Pers. Spec.
	<ul style="list-style-type: none"> Latch-bolt and dead-bolt 	4	-	28	2	85	35	67	2,420	1	1 56530 28 0				
		4	-	28	2	85	35	67	2,120	5	1 56530 48 0				
	<ul style="list-style-type: none"> Latch-bolt and dead-bolt Pre-setting for additional locking points 	4	-	28	2	85	35	67	2,800	1	1 56535 28 0				
		4	-	28	2	85	35	67	2,300	5	1 56535 48 0				
	<ul style="list-style-type: none"> Dead-bolt only Pre-setting for additional locking points 	5	-	28	2	85	35	67	2,650	1	1 B6525 28 0				
		4	-	38	2	85	35	67	2,650	1	1 B6525 38 0				
		5	-	28	2	85	35	67	2,350	5	1 B6525 48 0				
		4	-	38	2	85	35	67	2,350	5	1 B6525 58 0				
	<ul style="list-style-type: none"> Latch-bolt and dead-bolt Pre-setting for additional locking points 	4	-	28	2	85	35	67	2,800	1	1 B6535 28 0				
		3	-	38	2	85	35	67	2,800	1	1 B6535 38 0				
		4	-	28	2	85	35	67	2,300	5	1 B6535 48 0				
		3	-	38	2	85	35	67	2,300	5	1 B6535 58 0				

Drawings and dimensions

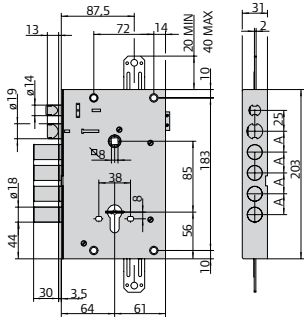

15510, 15515
A = 25 - 27 - 28 - 32 - 38

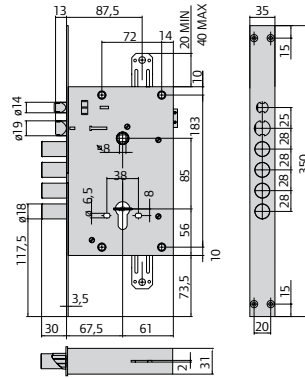

15530, 15535

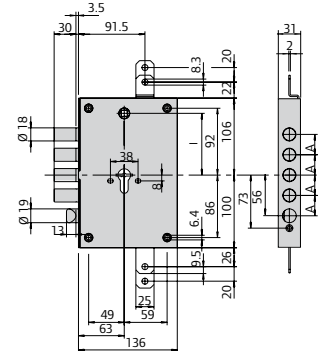

B6505, B6515
I = 85, A = 25-28-38

B6615
I = 92, A = 25-28-38

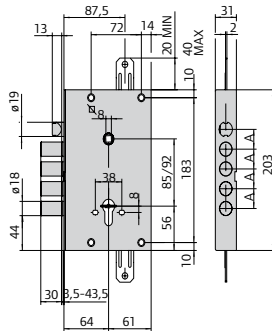

56510, 56515
A = 25 - 27 - 28 - 32 - 38

56615
A = 27 - 28 - 38 (=92)

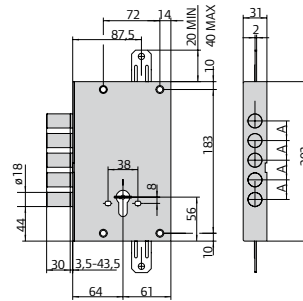

56500, 56505
A = 25 - 27 - 28 - 32 - 38

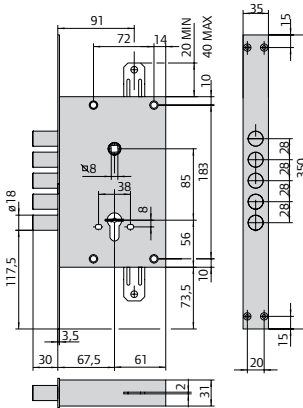

56520, 56525

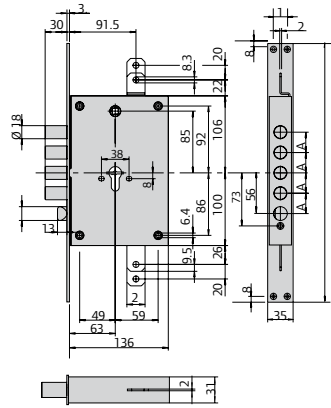

B6525, B6535, B7525, B7535
A = 28-38

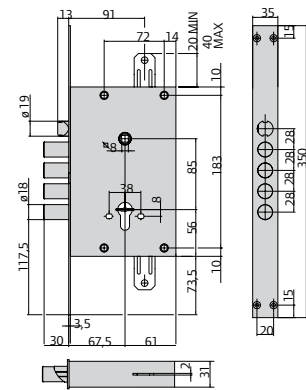

56530, 56535

About Allegion

Allegion (NYSE: ALLE) creates peace of mind by pioneering safety and security. As a \$2 billion provider of security solutions for homes and businesses, Allegion employs more than 7,800 people and sells products in more than 120 countries across the world. Allegion comprises 23 global brands, including strategic brands CISA®, Interflex®, LCN®, Schlage® and Von Duprin®. For more, visit allegion.com



ALLEGION

BRICARD ■ Briton ■ CISA ■ interflex

CISA SpA
Via Oberdan 42 - 48018 Faenza (RA) Italy
Tel +39 0546 677111 - Fax +39 0546 677150
cisa.vendite@allegion.com
cisa.com - cisahotels.com



© 2014 Allegion
allegion.com